

Description

- Operation mode and max sensing range:
 - Thru-beam: 0–45 m
 - Diffuse proximity: 0–3 m
 - Retro reflective: 0–12 m
 - Polarised retro reflective: 0–10 m
 - Background suppression: 0–1.5 m
- Compact rectangular housing (50 x 50 mm)
- Cable or rotatable plug connection
- Sensitivity adjustment via potentiometer
- Switch selectable light or dark function
- Adjustable on/off time delay
- Power, output and signal level indicators
- 10-30 V dc or 12-240 V ac/dc supply voltage
- 4 wire, NPN/PNP transistor output or 5 wire relay output

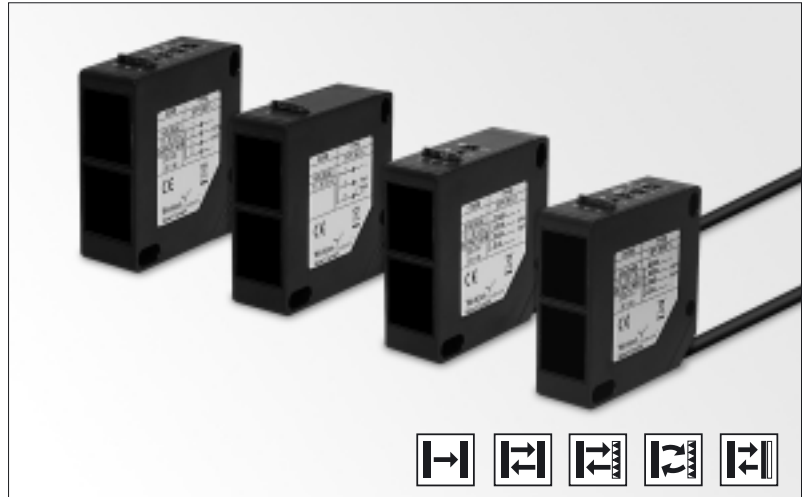

The SP 2000 series consists of a self-contained transmitter SPT and receiver SPR, which are to be used in thru-beam mode, an SPP for diffuse proximity, SPRR for retro-reflective, SPPR for polarised retro-reflective and SPBS for background suppression. All are offered with sensitivity adjustment via integral potentiometer with either cable or 180° rotatable plug connection.

The complete series is available either as a 4 wire, NPN/PNP transistor output with 10-30 V dc supply voltage or as a 5 wire, relay output with a 12-240 V ac/dc supply voltage both offering switch selectable light or dark function and potentiometer adjustable 0-10 sec on/off time delay.

The test input in the 10-30 V dc, SPT is intended to be used for disabling or enabling the transmitter power temporarily for test purposes or for multiplexing applications.

The dc series is protected against reverse polarity of power supplies, test input and output signals. The output is protected against short circuit and inductive loads.

Technical Data

		SPT	SPR	SPP	SPRR	SPPR	SPBS
Supply voltage	ac/dc	12-240 V dc / 20-240 V ac					
	dc	10 – 30 V dc					
Voltage ripple		+/- 15 %					
Output	Relay	–	1 open / 1 close, 240 V ac / 3 A				
	Transistor	–	200 mA / 30 V dc				
Reverse polarity protected	dc	Yes					
Short circuit protected	dc	–	Yes				
Current consumption	ac	< 70 mA					
	dc	< 65 mA					
Maximum operation frequency	ac	–	25 Hz				
	dc	–	250 Hz				
Response time t_{ON} / t_{OFF}	ac	–	20 ms / 20 ms				
	dc	–	2 ms / 2 ms				
Delay t_{ON} / t_{OFF}		–	0 – 10 sec, adjustable				
Power on indicator		Green LED					
Output indicator		–	Yellow LED				
Signal status indicator		–	Red LED				
Hysteresis		–	20 – 30 %	5 – 15 %	Approx. 10 %	Approx. 10 %	3 – 10 %
Light source		Infrared (880 nm)	–	Infrared (880 nm)		Visible Red (670 nm)	Infrared (880 nm)
Opening angle		–	+/- 2,5°	+/- 5°	+/- 1,5°		+/- 5°
Emission angle		+/- 2°	–	+/- 1,5°	+/- 2°		+/- 1,5°
Housing material	Sensor housing	Polycarbonate / ABS					
	Front lens	Polycarbonate					
Cable, PVC Ø 4,9 mm	ac	2 x 0,20 mm ²	5 x 0,20 mm ²				
	dc	3 x 0,20 mm ²	4 x 0,20 mm ²				

Environmental Data		SPT	SPR	SPP	SPRR	SPPR	SPBS
Vibration		10 – 55 Hz, 0.5 mm					
Shock		30 g					
Light immunity	@ 5° incidence	–	25 000 lux	–	25 000 lux		–
	@ 15° incidence	–	–	25 000 lux	–	25 000 lux	
Temperature, operation		–20 to +55 °C					
Temperature, storage		–40 to +80 °C					
Sealing class		IP 67					
Approvals	ac	CE 					
	dc	CE					

Available Types

Transmitter	Type	Power Supply	Control Feature	Time Delay	Connection	5 m cable	4 pin, M12 plug	Range
					Output	Order Reference		
2645	10 – 30 V dc	10 – 30 V dc	Test input	–	–	SPT 2645 5	SPT 2645 J	45 m
	12 – 240 V ac / dc	12 – 240 V ac / dc	–	–	–	SPT 2945 5	–	

Receiver	2645	10 – 30 V dc	Sensitivity potentiometer and light/dark switch	On/Off Delay	NPN/PNP	SPR 2645T 5	SPR 2645T J	0-45 m
	–	–		SPR 2645 5		SPR 2645 J		
2945	12 – 240 V ac / dc	12 – 240 V ac / dc	On/Off Delay	Relay	SPR 2945T 5	–		
	–	–			SPR 2945 5	–		

Diffuse Proximity	2603	10 – 30 V dc	Sensitivity potentiometer and light/dark switch	On/Off Delay	NPN/PNP	SPP 2603T 5	SPP 2603T J	0-3 m
	–	–		SPP 2603 5		SPP 2603 J		
2903	12 – 240 V ac / dc	12 – 240 V ac / dc	On/Off Delay	Relay	SPP 2903T 5	–		
	–	–			SPP 2903 5	–		

Retro-Reflective	2612	10 – 30 V dc	Sensitivity potentiometer and light/dark switch	On/Off Delay	NPN/PNP	SPRR 2612T 5	SPRR 2612T J	0-12 m
	–	–		SPRR 2612 5		SPRR 2612 J		
2912	12 – 240 V ac / dc	12 – 240 V ac / dc	On/Off Delay	Relay	SPRR 2912T 5	–		
	–	–			SPRR 2912 5	–		

Note: Reflector to be ordered separately.

Polarised Retro-Reflective	2610	10 – 30 V dc	Sensitivity potentiometer and light/dark switch	On/Off Delay	NPN/PNP	SPPR 2610T 5	SPPR 2610T J	0-10 m
	–	–		SPPR 2610 5		SPPR 2610 J		
2910	12 – 240 V ac / dc	12 – 240 V ac / dc	On/Off Delay	Relay	SPPR 2910T 5	–		
	–	–			SPPR 2910 5	–		

Note: Reflector to be ordered separately.

Background Suppression	2600	10 – 30 V dc	Range potentiometer and light/dark switch	On/Off Delay	NPN/PNP	SPBS 2600T 5	SPBS 2600T J	0-0,5 m
	–	–		SPBS 2600 5		SPBS 2600 J		
2900	12 – 240 V ac / dc	12 – 240 V ac / dc	On/Off Delay	Relay	SPBS 2900T 5	–		
	–	–			SPBS 2900 5	–		
2601	10 – 30 V dc	10 – 30 V dc	On/Off Delay	NPN/PNP	SPBS 2601T 5	SPBS 2601T J		
	–	–			SPBS 2601 5	SPBS 2601 J		
2901	12 – 240 V ac / dc	12 – 240 V ac / dc	On/Off Delay	Relay	SPBS 2901T 5	–		
	–	–			SPBS 2901 5	–		

Connections		
AC/DC		
Supply + / ~	Cable	M12 Plug / Cable
Supply - / ~	Brown	-
Output NC	Blue	-
Output NO	Grey	-
Output C	Black	-
DC		
Supply +	Brown	Pin 1 / Brown
Supply -	Blue	Pin 3 / Blue
SPT test input	Black	Pin 4 / Black
Output NPN	White	Pin 2 / White
Output PNP	Black	Pin 4 / Black

4 pin, M12

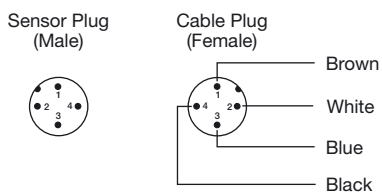

Refer to page 155 for extension cables

Wiring Diagrams

AC/DC Models

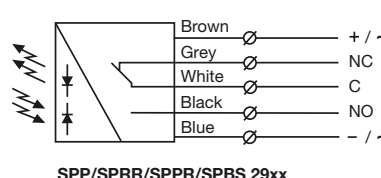
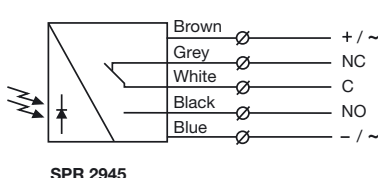
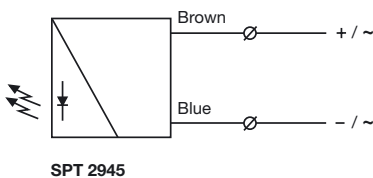

DC Models

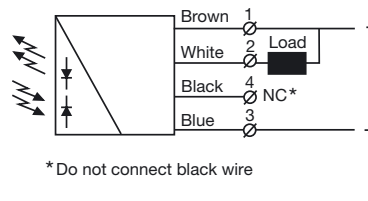
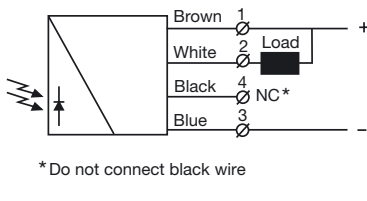
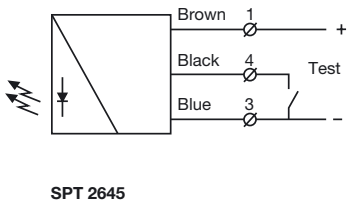

* Do not connect black wire

* Do not connect black wire

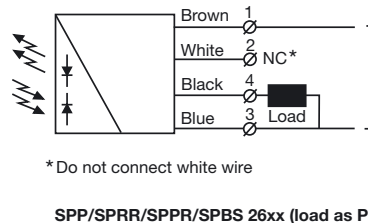
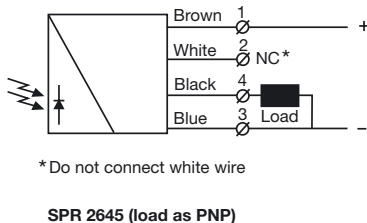

* Do not connect white wire

* Do not connect white wire

Dimensions and Descriptions

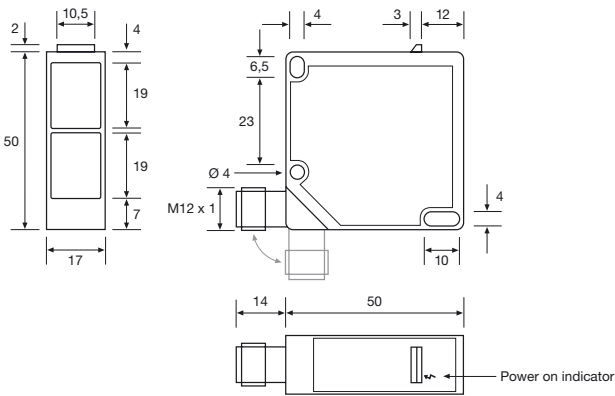

SPT 2645 J

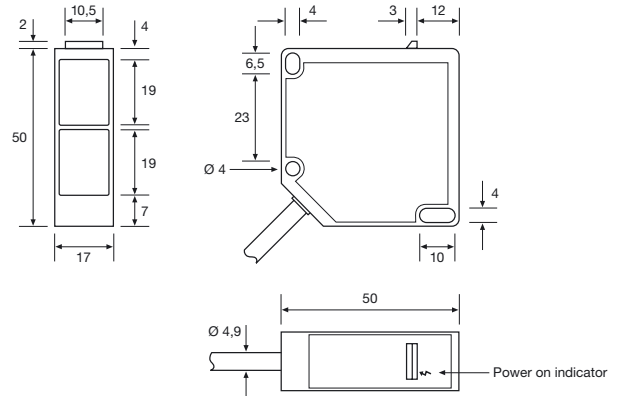

SPT 2x45 5

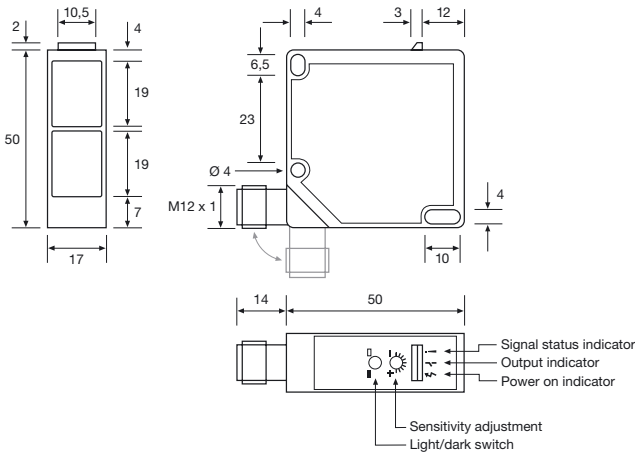

SPR/SPP/SPRR/SPPR/SPBS 26xx J

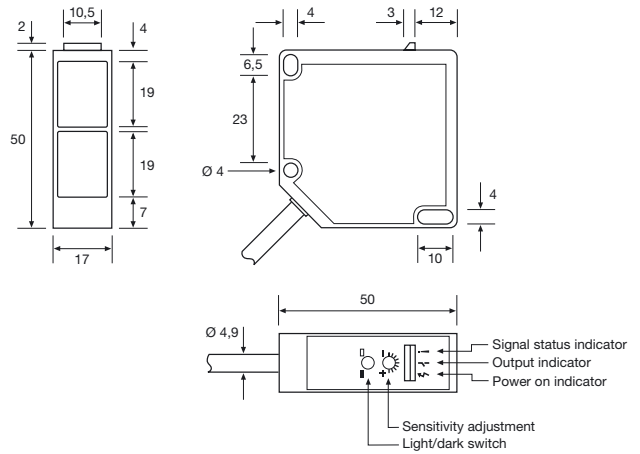

SPR/SPP/SPRR/SPPR/SPBS 2xxx 5

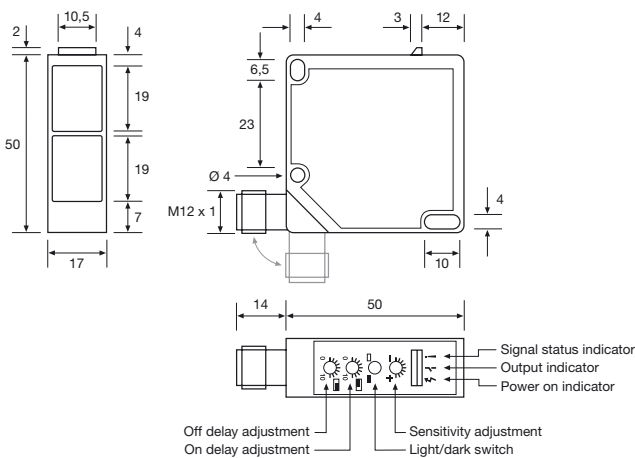

SPR/SPP/SPRR/SPPR/SPBS 26xxT J

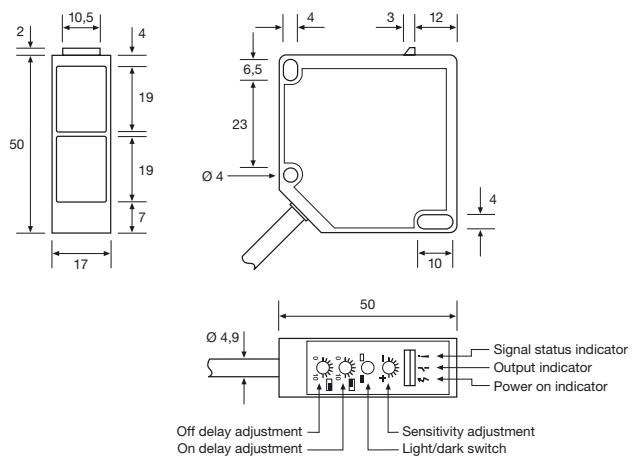

SPR/SPP/SPRR/SPPR/SPBS 2xxxT 5

(Units in mm)

Dimensions and Descriptions

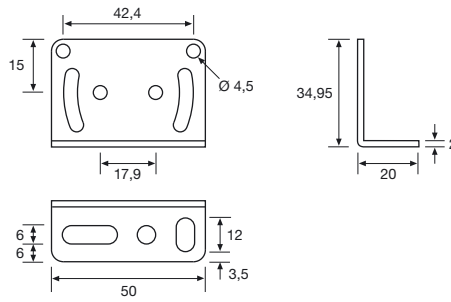

TR SP35-50 L
(Included with each unit)

Sensing Characteristics

Parallel Displacement

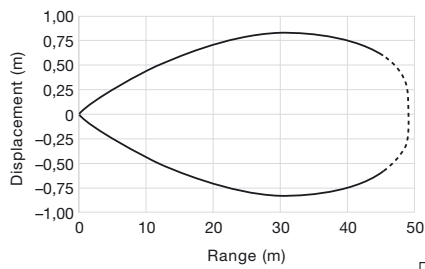

SPT 2x45 and SPR 2x45

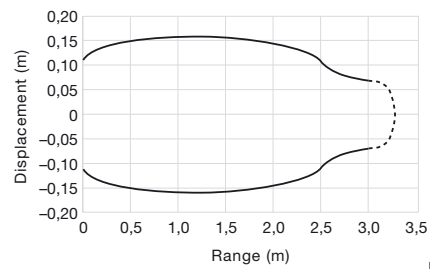
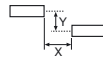

SPP 2x03

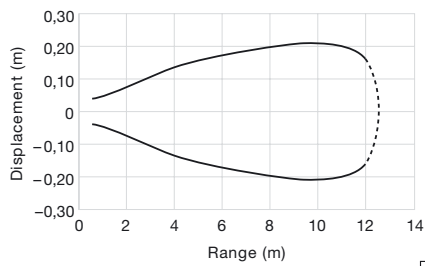

SPRR 2x12

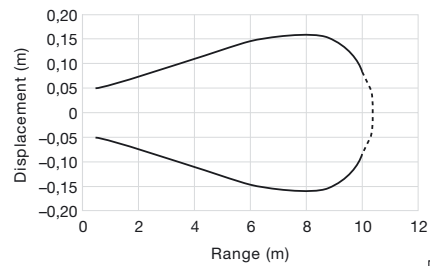

SPPR 2x10

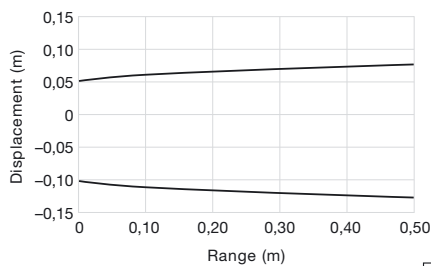

SPBS 2x00

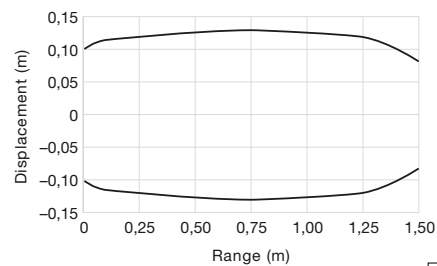

SPBS 2x01



Telco reserves the right to change specifications without notice.

Sensing Characteristics

Angular Displacement

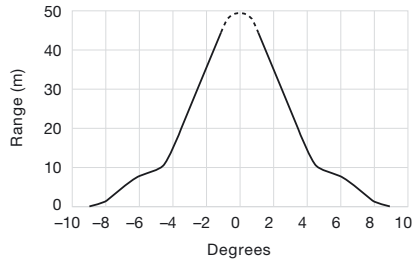

SPT

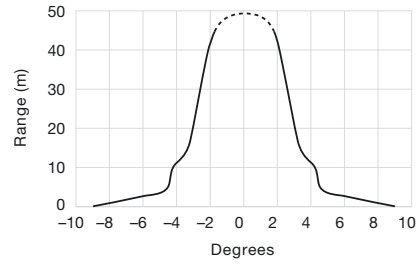

SPR



Telco reserves the right to change specifications without notice.